

YOUR ONE STOP SHOP!

CONSTRUCTION



HDD



FORESTRY



AGRICULTURE



TOOLING & PRODUCTS



**PERFORMANCE
GUARANTEED**

SALES >>> **ENGINEERING** >>> **MANUFACTURING** >>> **SERVICE** >>> **RENTAL**

AUSTRALIA

CANADA

UNITED STATES

TABLE OF CONTENT

CONSTRUCTION



CONICAL PICKS	1-8
CONICAL BLOCKS	9-10
OTHER TEETH	11-14
TOOLS & ACCESSORIES	15-18
PLUGS & CFA AUGER.....	19
DIRT TEETH	20-23
TAPER FIT TEETH	24-25
BUCKET TEETH	26-27
TAPER TEETH BLOCKS	28-29
FLAT CUTTER PICKS	30
FISHTAIL, AUGER PARTS & MORE.....	31-32
AUGER FLIGHTS	33-34
PILOT BITS	35-37
ADAPTERS	38-39
KELLY BOXES	40

FORESTRY



MULCHING TEETH	53
STUMP GRINDING TOOLS	54

HORIZONTAL DIRECTIONAL DRILLING



HDD TRIHAWK TEETH	41-42
HDD WELD ON TEETH	43-46
TRENCHER TEETH	47
DRILL BITS	48
HDD ACCESSORIES	49
TRIHAWK & THREAD REPAIR	50
REAMERS & RENTAL	51
WOMBAT	52

AGRICULTURE



**ASK FOR
EXTENDED
CATALOGUE**

CNC LATHES
10" Through Bore Capability



CNC MILLS
4 Axis Milling Available



INDUCTION HEATER
Induction Heating Services



**OUR MACHINERY ALLOWS US
TO PROVIDE IN-HOUSE SERVICE,
REPAIR, AND MANUFACTURING**

LARGE PRESS
Flight Bending Up To 72"



CONICAL PICKS: 55 & 74 SERIES

CP01 - 55 SERIES

Full Body, 16mm Cone Cap

BLOCK: C055

100

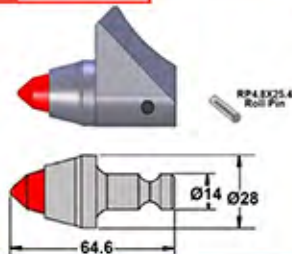

CP10 - 74 SERIES

Grooved/Narrow Body, 12mm S/Cone Insert

BLOCK: C-1S

75

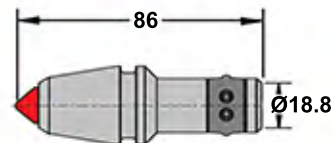

CP13 - 74 SERIES

Grooved/Narrow Body, 16mm S/Cone Cap

BLOCK: C-1S

75

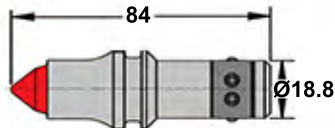

CP13 - PTAW1 - 74 SERIES

Grooved/Narrow Body, 12mm Cone Insert

BLOCK: C-1S

75

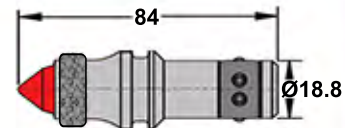

CONICAL PICKS: 74 & 76 SERIES

CP15

Full Body, 16mm D/Cone Cap

BLOCK: C-1S

75

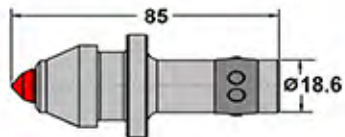

CP20B - 76 SERIES

Grooved/Narrow Body, 12mm Cone Insert

BLOCK: C-2S

50

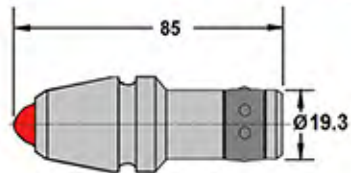

CP21 - 76 SERIES

Full Body, 16mm D/Cone Cap

BLOCK: C-2S

50

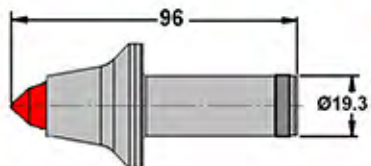

CP22 - 76 SERIES

Full Body, 16mm D/Cone Cap

BLOCK: C-2S

50

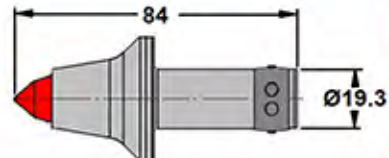

CONICAL PICKS: 76 SERIES

CP23L - 76 SERIES

Grooved/Narrow Body, 16mm D/Cone Cap

BLOCK: C-2S

50 

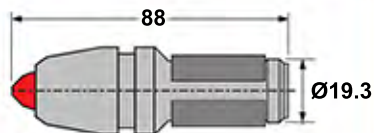

CP24 - 76 SERIES

Full Body, 16mm D/Cone Cap

BLOCK: C-2S

50 

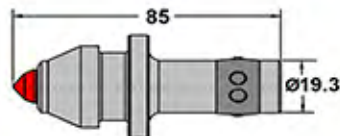

CP25 - 76 SERIES

Grooved Flanged Body, 12mm Cone Insert

BLOCK: C-2S

50 

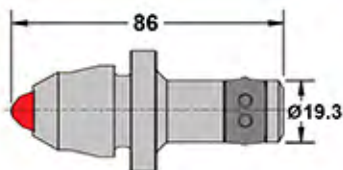

CP28W - 76 Series

Full Body, 18mm Bell Cap

BLOCK: C-2S

50 

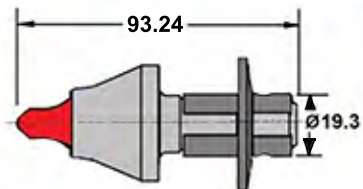

CONICAL PICKS: 76 & 86 SERIES

CP29W - 76 SERIES

Full Body, 18mm Bell Cap

BLOCK: C-2S

50 

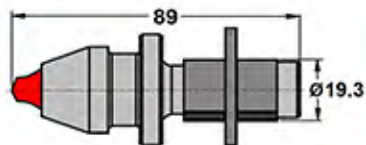

CP30B - 86 SERIES

Grooved/Narrow Body, 12mm Cone Insert

BLOCK: C-3S

50 



CP34L - 86 SERIES

Grooved Flanged Body, 12mm Cone Insert

BLOCK: C-3S

50 

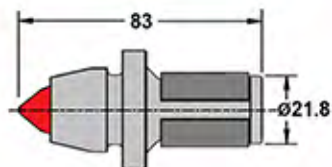

CP35L - 86 SERIES

Flanged Head Body, 12mm Cone Insert

BLOCK: C-3S

50 

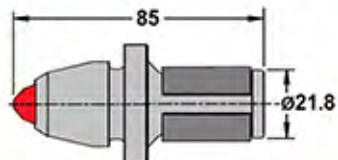

CONICAL PICKS: 86 SERIES

CP35ALR

HDD Carbide Tooth with Pocket Protection for Hard Conditions

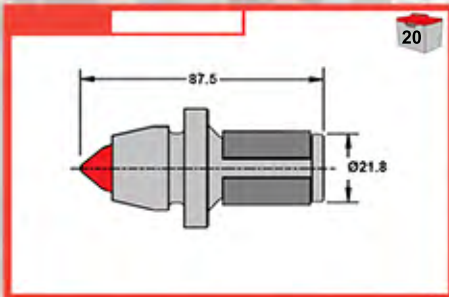

CP39 - 86 SERIES

Grooved/Narrow Body, 16mm Cone Insert

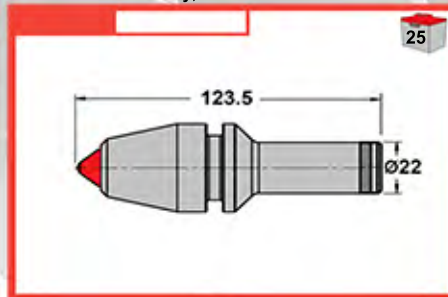

DID YOU KNOW?

*Hard Metals originated in Australia.
Canadian subsidiary was established in 2015.*



CONVERSION CHART

INCHES	MILLIMETRES	INCHES	MILLIMETRES
1/16	1.59	9/16	14.29
1/8	3.18	5/8	15.88
3/16	4.76	11/16	17.46
1/4	6.35	3/4	19.05
5/16	7.94	13/16	20.64
3/8	9.53	7/8	22.23
7/16	11.11	15/16	23.81
1/2	12.70	1	25.40

CONICAL PICKS: 99 SERIES

CP41 - 99 SERIES

Grooved Narrow Body, 12mm Cone Insert

BLOCK: C-4S

25

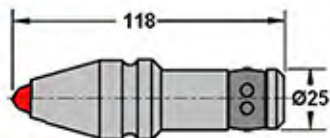

CP42 - 99 SERIES

Grooved Narrow Body, 16mm Cone Insert

BLOCK: C-4S

25

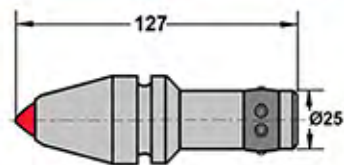

CP43 - 99 SERIES

Grooved/Slim Body, 12mm S/Cone Insert

BLOCK: C-4S

25

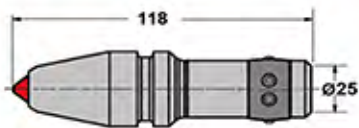

CP46 - 99 SERIES

Full Body, 19mm Ballistic Insert

BLOCK: C-4S

25

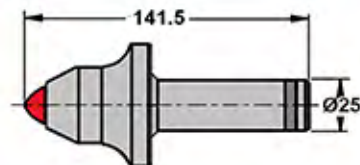

CONICAL PICKS: 116 SERIES

CP60 - 116 SERIES

Stepped Shank, Grooved Narrow Body, 22mm Ballistic Insert

BLOCK: C-6S

15

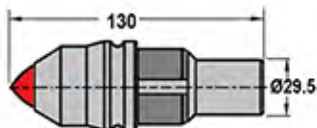

CP60B - 116 SERIES

Stepped Shank, Grooved Narrow Body, 17.50mm Ballistic Insert

BLOCK: C-6S

10

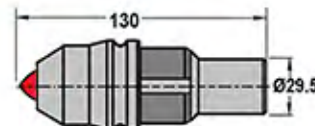

CP60PTAW-1 - 116 SERIES

Stepped Shank, Grooved Narrow Body, 22mm Ballistic Insert, Carbide Buttons

BLOCK: C-6S

15

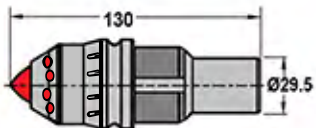

CP60PTAW-2 - 116 SERIES

Hard Surfacing, Stepped Shank, Grooved Narrow Body, 22mm Ballistic Insert

BLOCK: C-6S

15

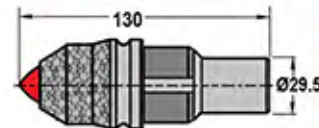

CONICAL PICKS: 116 SERIES

CP60-19L - 116 SERIES

Carbide Tooth with Pocket Protection for Hard Conditions

BLOCK: C-6S

10

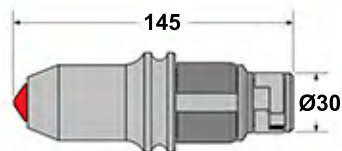

CP60-K19-S - 116 SERIES

Flanged Head Body

BLOCK: C-6S

10

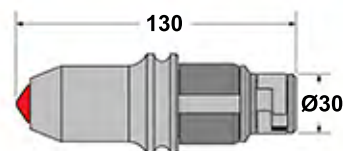

CP64 - 116 SERIES

Carbide Tooth for Hard Conditions

BLOCK: C-6S

10

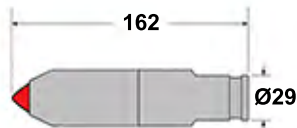

SNAP RING PLIERS



CONICAL BLOCKS

C055

Normal Duty, 55 Series

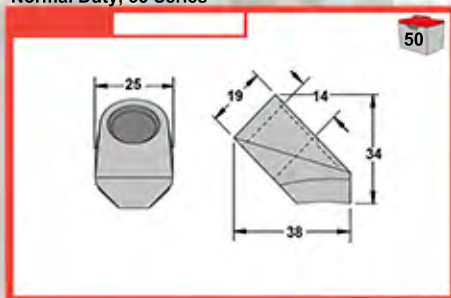

C-1S

Slim Line, 74 Series

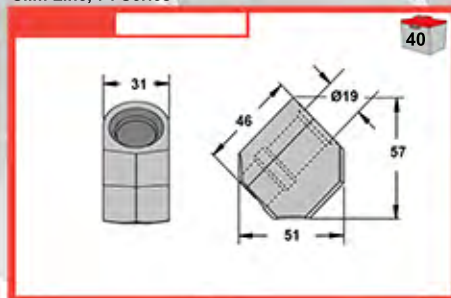

C-2

Heavy Duty, 76 Series

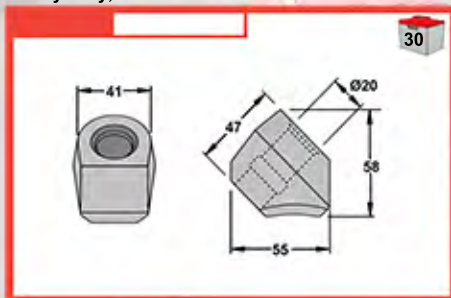

C-2S

Slim Line, 76 Series

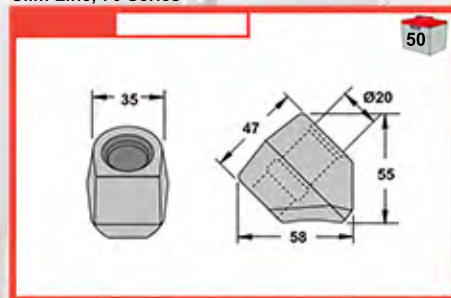

CONICAL BLOCKS

C-3S

Slim Line, 86 Series

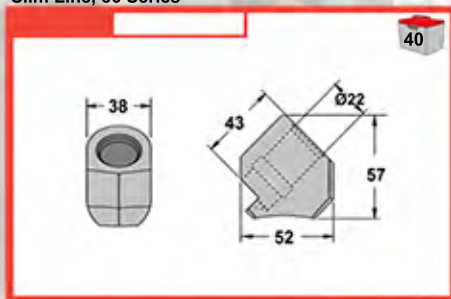

C-4S

Slim Line, 76 Series

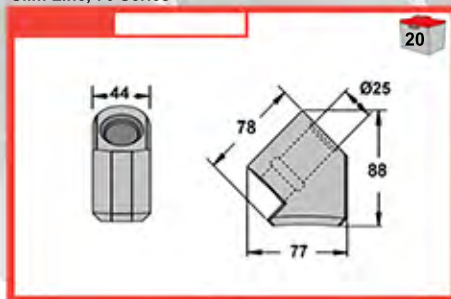

C-6S

Slim Line, 86 Series

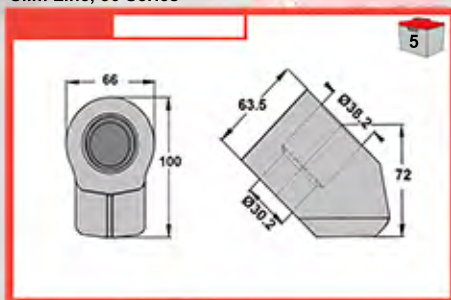

C-6F

Heavy Duty, 99 Series

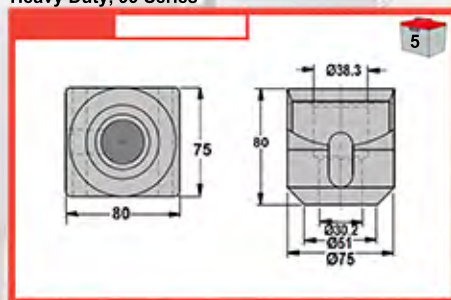

CONICAL PICKS: 118 SERIES

CP70 - 118 SERIES

Straight Shank, Full Body, 17mm S/Cone Insert

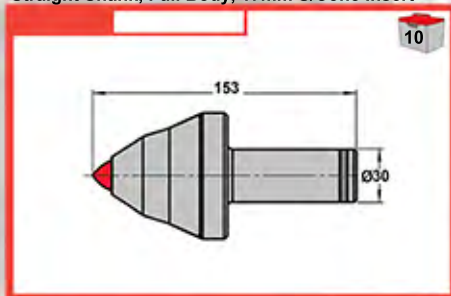

CP75 - 118 SERIES

Straight Shank, Mid Retainer, 17mm Mushroom Insert

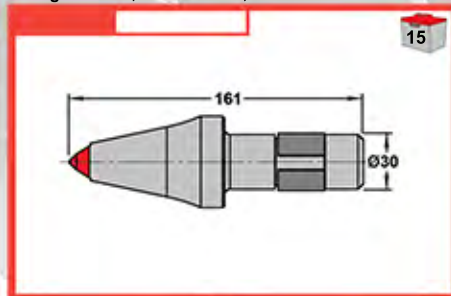

CP77PRE - 118 SERIES

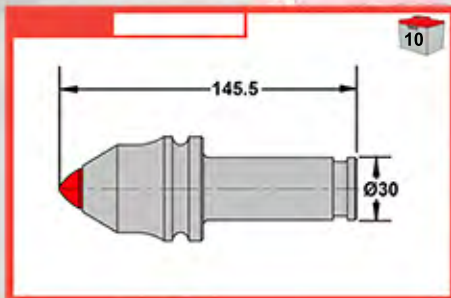

CP78PRE - 118 SERIES

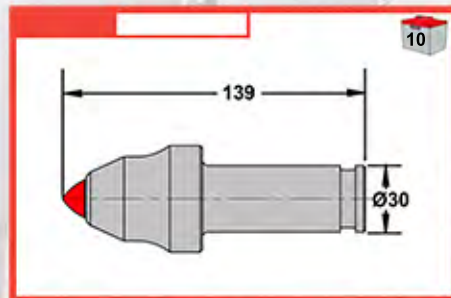

FLAT PICKS & OTHER TEETH

CPF70

Flat Pick

BLOCK: C-6F

6

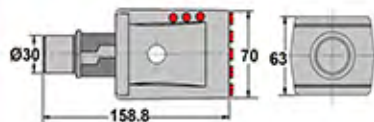

CPF150

Flat Pick

HOLDER: C-3S / B-3S

35

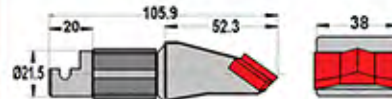

CPF08

Dragon Teeth

HOLDER:

25

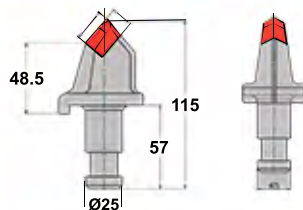

CPF607

Dragon Teeth

HOLDER:

25

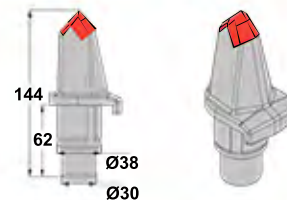

OTHER TEETH

QCB-39

Alloy Carbide casing Tooth for Hard Conditions

POCKET: QCB-39H

15

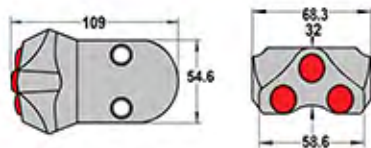

QCB-39R

Carbide Casing Tooth for Hard Conditions

POCKET: QCB-39H

15

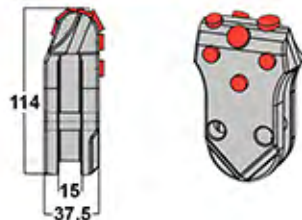

QCB-39S

Alloy Carbide Casing Tooth with Carbide Side

POCKET: QCB-39H

15

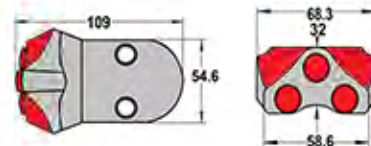

QCB-39H

Pocket

TOOTH: QCB-39, 39R, 39S

15



OTHER TEETH

QCB-46

Heavy Duty Carbide Casing Tooth for Hard Conditions

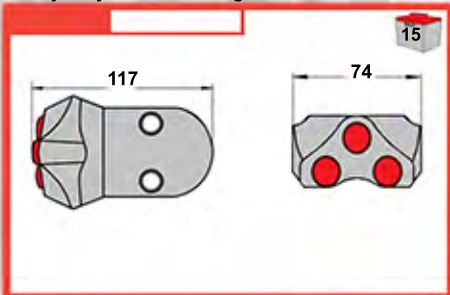

QCB-47

Heavy Duty Carbide Casing Tooth for Hard Conditions

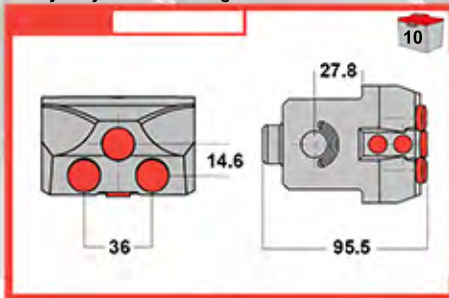

QCB-60 INNER/OUTER

Heavy Duty Carbide Casing Tooth for Hard Conditions

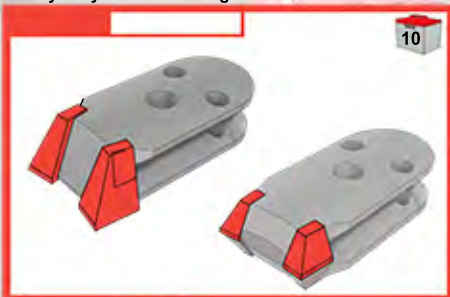

ROLLPINS

For QCB-39 & QCB-46

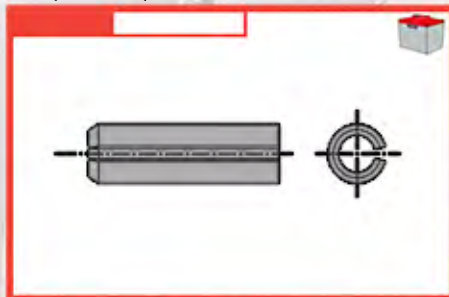

TOOLS & ACCESSORIES

CDA SHOE

Holder



FUN FACT

Hardmetals has a wide range of augers, hole openers, buckets, hammers, bellling tools and casing pullers available for rentals!



WBA-38 & 38X

Wear pad, RC50 Available

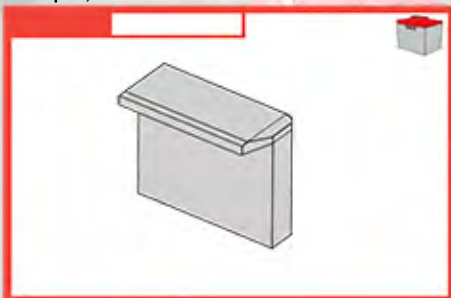

Quantity Available
As Requested

WBA-38HF

Wear pad, Hard Surfacing

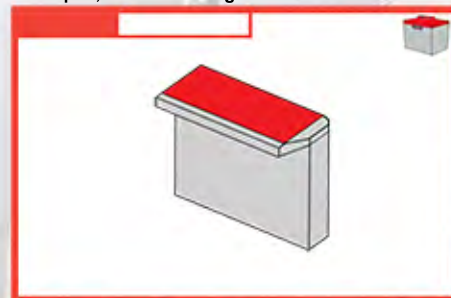

TOOLS & ACCESSORIES

EMBRV-02

Threaded conical joint

PIN/PUCK: EMBRV-08 & 10

15



EMBRV-03

Non-threaded conical joint

PIN/PUCK: EMBRV-08 & 10

15



EMBRV-08

Threaded Pin/Puck For EMBRV-02

JOINT: EMBRV-02 & 03

15



EMBRV-10

Threaded Pin/Puck For EMBRV-03

JOINT: EMBRV-02 & 03

15



TOOLS & ACCESSORIES

EMBRV 32 & 32 Modified

Lock Pin

HOLDER: EMBRV-32H

20

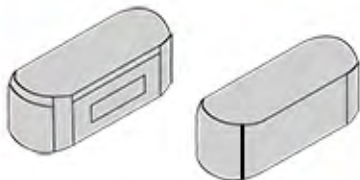

EMBRV-32H

Holder

LOCK PIN: EMBRV-32

20



WBA04

Weld on Bar with Carbide Insert

25

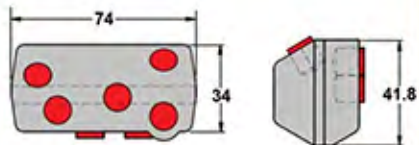

WBA55

Weld on Bar with Carbide Insert

50

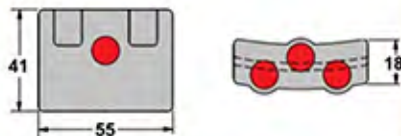

TOOLS & ACCESSORIES

TEETH PULLER

Interchangeable Head, All Sizes Available

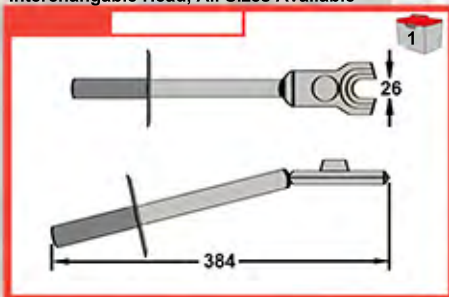

HAMMER TOOTH PULLER

Interchangeable Head, Custom Sizes Available



REMOVER

Pin

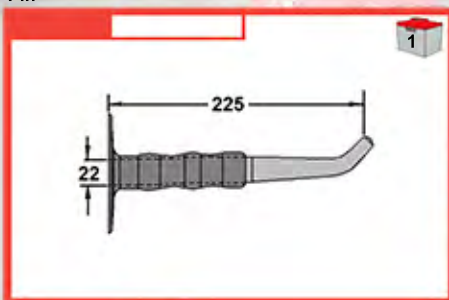

Extraction tools can be
custom made
as required

INTERCHANGEABLE HEAD

For Hammer Tooth Puller, All Sizes Available Upon Request



PLUGS & CFA AUGER

EMAPLUG-1

5 Inch Plug



EMAPLUG-2

6 Inch Plug



HOLLOW STEM

Drill Head & Accessories



CFA AUGER

Call Us For Details

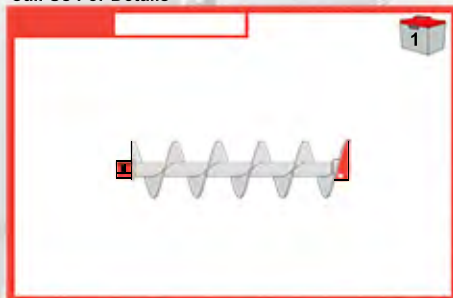

DIRT TEETH

EMF505 - 35 SERIES

Plain Dirt Tooth

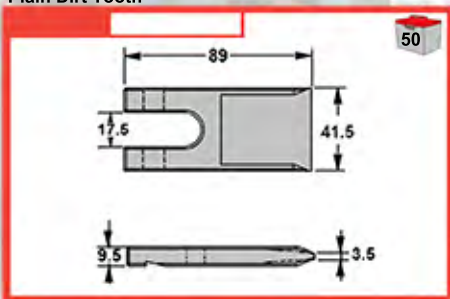

EMF506 - 35 SERIES

Plain Chisel Tooth

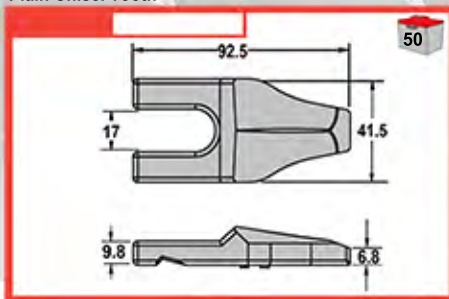

EMF508 - 35 SERIES

Chisel Tooth, Carbide Tipped

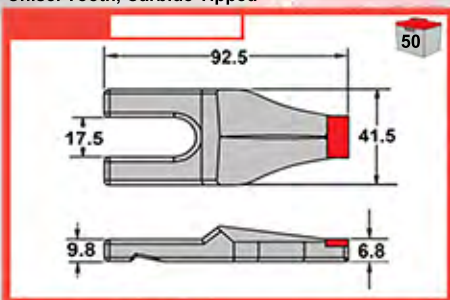

EMF509 - 35 SERIES

Chisel Tooth, Carbide Tipped, FW Insert

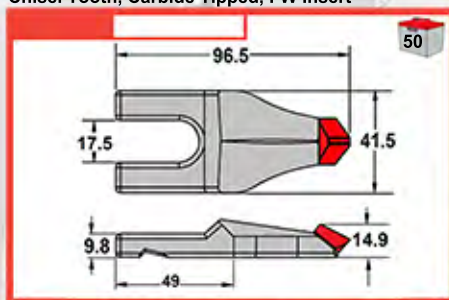

DIRT TEETH

EMF527 - 35 SERIES

Flat Tooth, Carbide Tipped

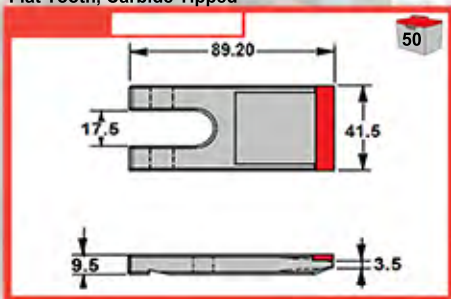

EMF535 - 35 SERIES

Heavy Duty, Triple Teeth, Carbide Tipped

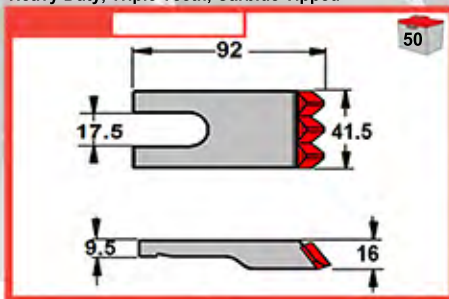

EMF535-14 - 35 SERIES

Heavy Duty, Triple Teeth, Carbide Tipped

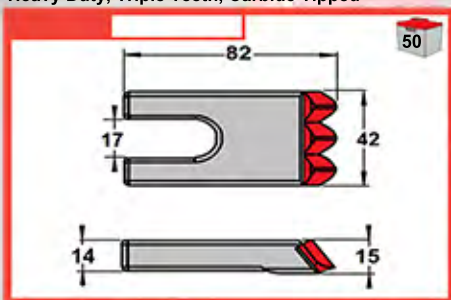

EMF660 - 35 SERIES

T36, Tooth Holder

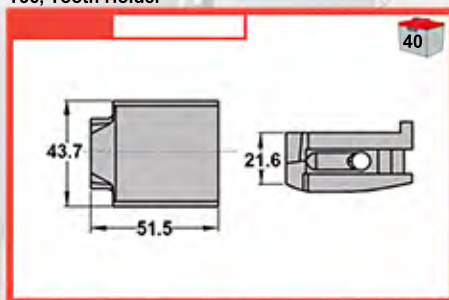

DIRT TEETH

EMP1650

For Regular Dirt Conditions

POCKET: WT-50

40

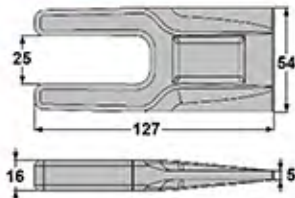

EMP1652

Gage Tooth for Regular Dirt Conditions

POCKET: WT-50

30

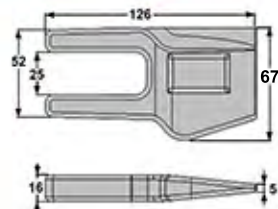

EMP1656

Carbide Tooth for Hard Conditions

POCKET: WT-50

20

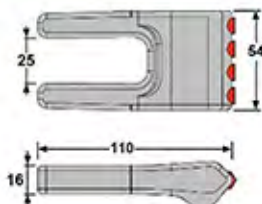

EMP1658

Carbide Gage Tooth for Hard Conditions

POCKET: WT-50

30

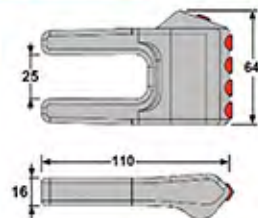

DIRT TEETH

EMP2070

For Regular Dirt Conditions

POCKET: WA & FA 70

40



EMP2072

Gage Tooth for Regular Dirt Conditions

POCKET: WA & FA 70

30

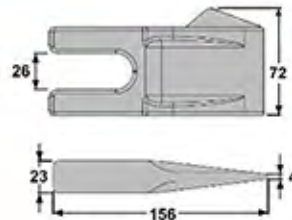

EMP2077

Carbide Tooth for Hard Conditions

POCKET: WA & FA 70

30

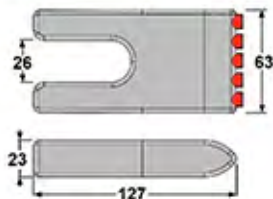

EMP2078

Carbide Gage Tooth for Hard Conditions

POCKET: WA & FA 70

20

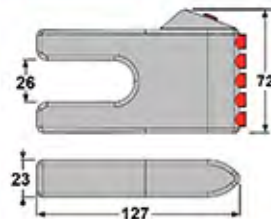

TAPER FIT TEETH

EMP60

Dirt Tooth for Regular Conditions

POCKET: W0-5

10

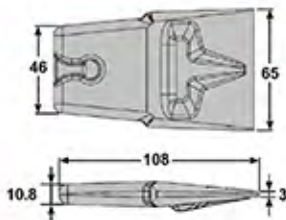

EMP132

For Regular Dirt Conditions

POCKET: W0-5

10

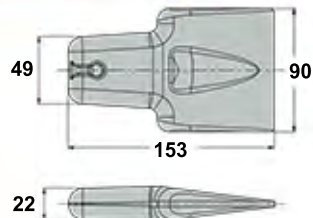

EMP134

Dirt Tooth for Regular Conditions. Double Offset

POCKET: W0-5

10

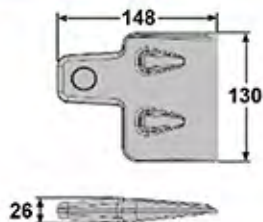

EMP201

For Regular Dirt Conditions

POCKET: W0-5

15

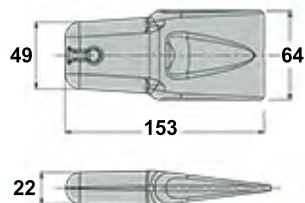

TAPER FIT TEETH & REAMERS

EMP211

Dirt Tooth for Hard Conditions. Single Offset

POCKET: W0-5

15

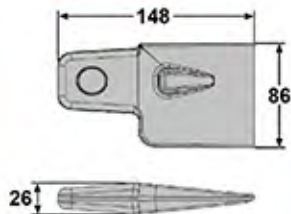

EMP299

Carbide Tooth for Hard Conditions. "Tiger Paw"

POCKET: W0-5

10

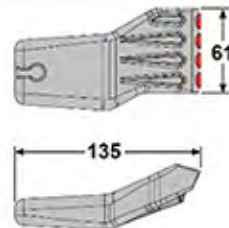

EMPWO-1

Pocket, commonly used on Belling Tools

10



EMPWO-5

Pocket

10



BUCKET TEETH

EMP230TW

Twin Tiger Point Side Pin Tooth

SHANK: CL-1001-23

10



EMP18SL

Standard Top Pin Tooth

SHANK: 845-18

10



EMP250

Standard Side Pin Tooth

SHANK: 250

10



EMPX220

Standard Top Pin Tooth

SHANK: 220WN

10



BUCKET TEETH

EMX220F

Flared Top Pin Tooth

SHANK: CL-1001-23



EMCL-1001-23

Side Pin Shank



EM550-LOD

Front End Side Pin Loader Tooth

SHANK: 250



EM845-18

Top Pin Shank



TAPER TEETH BLOCKS

EMPWO-1

Pocket, commonly used on Belling Tools



EMPWO-5

Pocket



EMPWO-2

Pocket, commonly used on Belling Tools



EMPWT-50

Pocket



TAPER TEETH BLOCKS

EMBRV-H85

Block



EMBHR-39

Single Shoulder Block



EMBHR-39HD

Single Shoulder Heavy Duty Block



EMB-75 CEC

Double Shoulder Block



FLAT CUTTER PICKS

EM410A-F

Flat Cutter Pick, 14mm Insert

HOLDER: F-2S

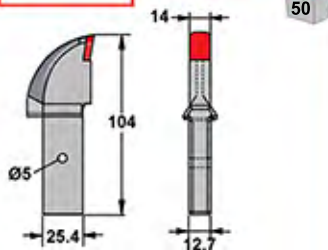

EM411-F

Flat Cutter Pick, 19mm Insert

HOLDER: F-2S

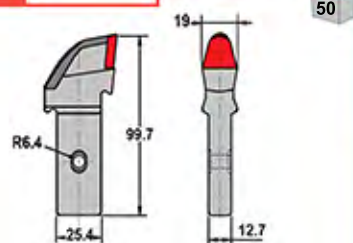

EM411-P

Flat Cutter Pick, 14mm Insert (FW8B)

HOLDER: F-2S

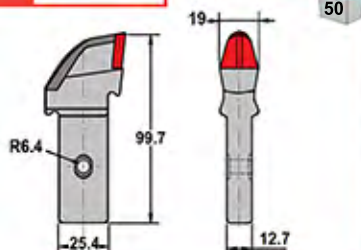

F-2S

Flat Cutter Pick, Block Forged

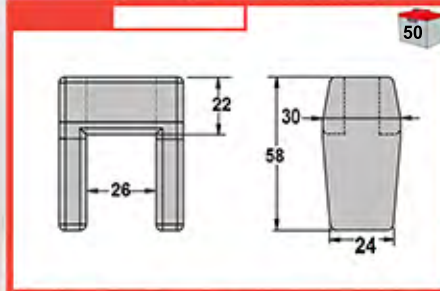

FISHTAIL & AUGER PARTS

EMF580

SB35 Plain, Fishtail Pilot

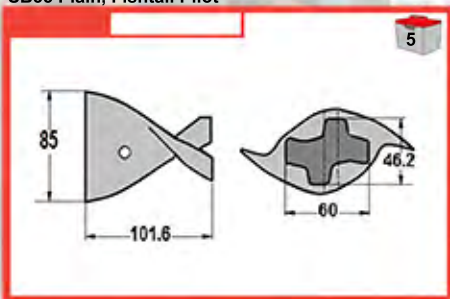

EMF590

SB45 Plain, Fishtail Pilot

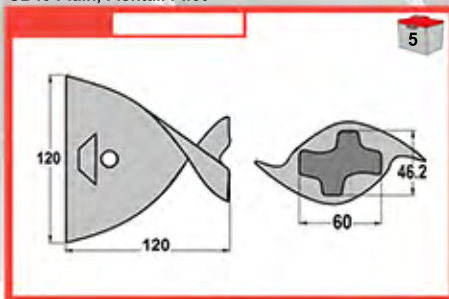

EMF610

SB35 TC, Fishtail Pilot, Carbide Tipped

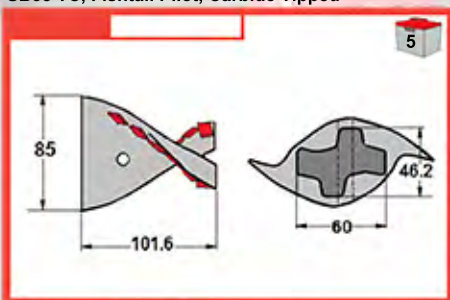

EMF611

SB45 TC, Fishtail Pilot, Carbide Tipped

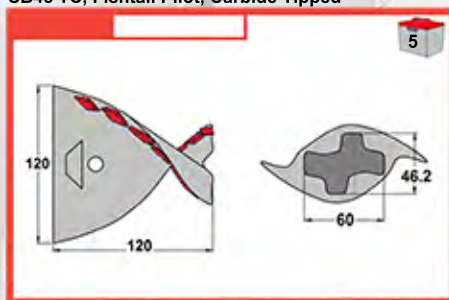

FISHTAIL & AUGER PARTS

EMF612

SB35 HD TC, Fishtail Pilot, Carbide Tipped, Heavy Duty

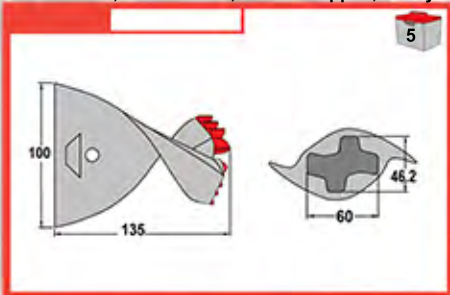

EMF635

SB35 Weld-on Drive Lug

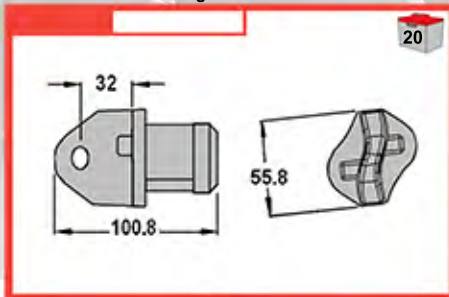

PCF-05H

Holder For PFC-05

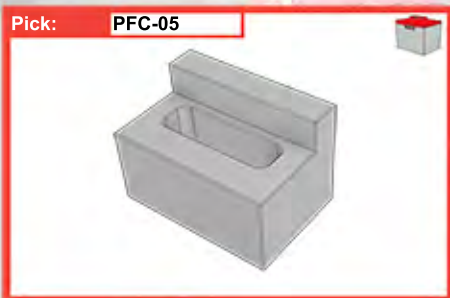

PFC-05

Carbide Tipped HDD Tooth



AUGER FLIGHTS

118 UPIN

U-Pin



158 UPIN

U-Pin

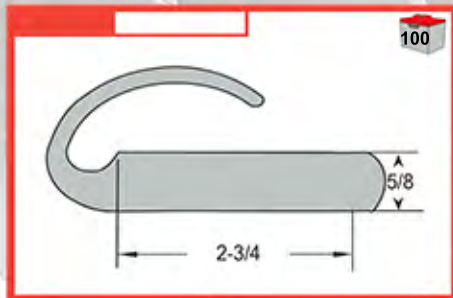

378 UPIN

U-Pin

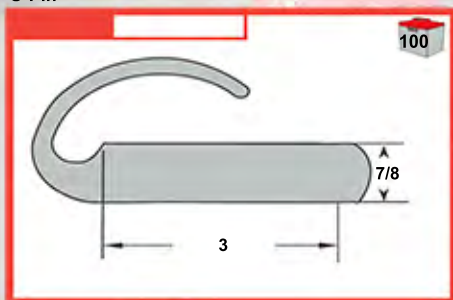

SCREW PILES

Available as requested

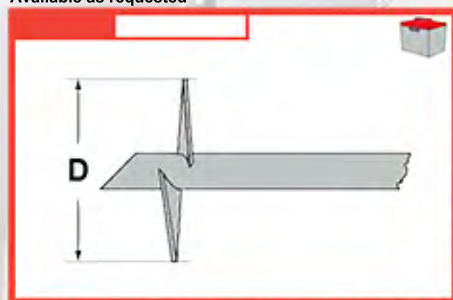

AUGER FLIGHTS, TOOLS, CASINGS

AUGER RENTAL

Available As Requested, All Sizes

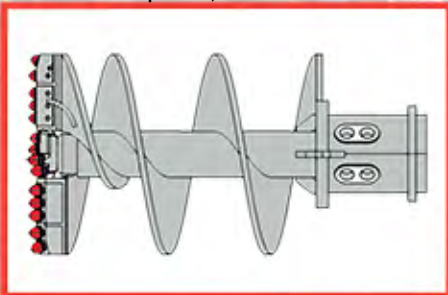

AUGER FLIGHT MANUFACTURING

Available As Requested

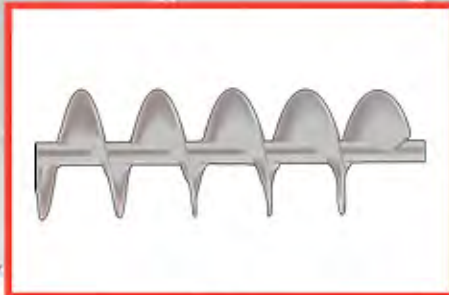

BELLING TOOLS



**RENTALS
AVAILABLE!**

CORE BARREL



PILOT BITS

EM434-RP

Step Pilot



EM614-CP

Chevron Pilot



All sizes available
as requested

EM358-3WP

3 Way Pilot, HDF Box



GB358

Gatorback bit



PILOT BITS

EM18RCP-H

Tooth Pilot, Custom Connection Available Upon Request



EM10RCP-H

4 Tooth Pilot, CP40 Series Teeth

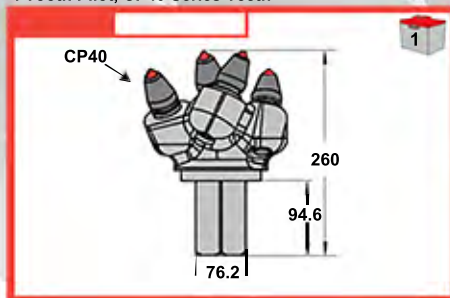

EM18RCP-S

4 Tooth Pilot, CP60 Series Teeth

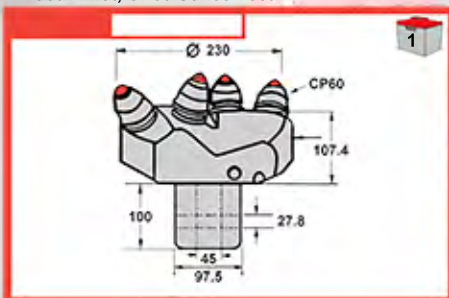

EM8RCP-TCF

4 Tooth Pilot, CP40 Series Teeth

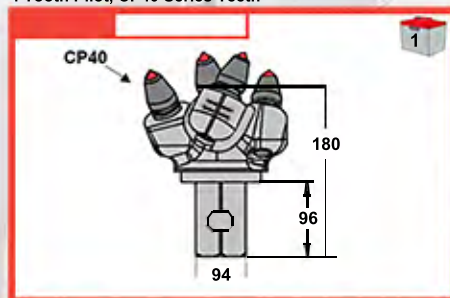

PILOT BITS

EMDB-S250

Fishtail, 2-1/2" Square I.D. Box



EMDBH-S3

Fishtail, 3" Square I.D. Box



EMMM-1

Fishtail, 1-3/4" Square Shank



EMF-238

Fishtail, 2-3/8" Pin - Thread As Required



ADAPTERS

EMDB-250

2-1/2" Square Weld On Adapter



EMDB-175

Adapter with 1-3/4" Square I.D. x 4" Round O.D.



EMDB-3

3" Square Weld On Adapter



EMA212-6

Adapter with 2-1/2" Square I.D. x 6" Round O.D.



ADAPTERS

EMA4-7

Adapter with 4" Square I.D. x 7" Round O.D.



EMA4-8

Adapter with 4" Square I.D. x 8" Round O.D.



DYR-NCB-8-12

Dynalloy Hardfacing



KELLY BOX AD.

Available In All Sizes As Requested



KELLY BOXES

EMH-250
Hexagonal Drive Hubs



EMH-300
Hexagonal Drive Hubs



EMAKB
Auger Kelly Boxes. Available in all sizes as requested



GEOROCFOR - OVERBURDEN SYSTEMS

Xs S

Complete Overburden and Rock Drilling System



Xs F

Floating System For Piling & Anchor Installation



**OUR OFFICIAL
SUPPLIER**

GEOROCFOR INC
ACCESSORIES

Xs W

Complex Operation Overburden System



Xs RU

Retrievable / Reusable System



HDD TRIHAWK TEETH

CP27HDD

Carbide Tooth for Hard Conditions

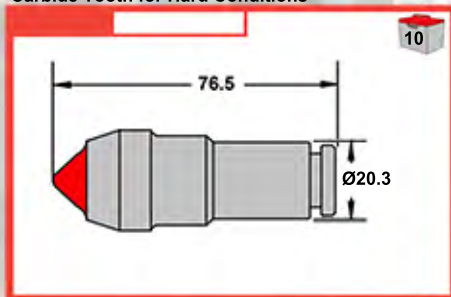

CP28HDD

Carbide Tooth for Hard Conditions

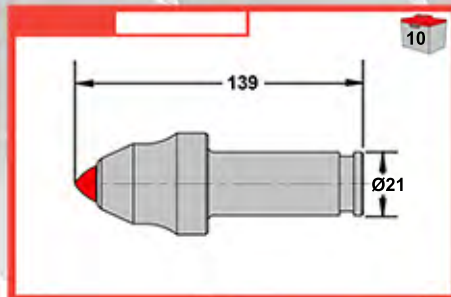

CP29HDD

Carbide Tooth for Hard Conditions

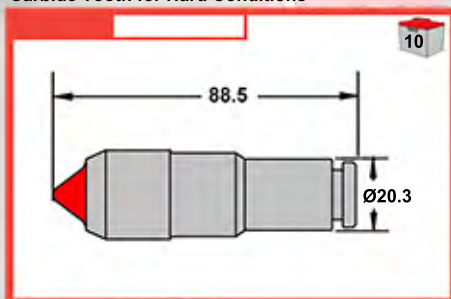

RAD TOOTH

Radius 2700, 3000, 3500 Series Available



HDD TRIHAWK TEETH

DID YOU KNOW?

Hardmetals can bend auger flights up to 72 inches in house!



Clay augers are available upon request!

CP49HDD

Carbide Tooth for Hard Conditions

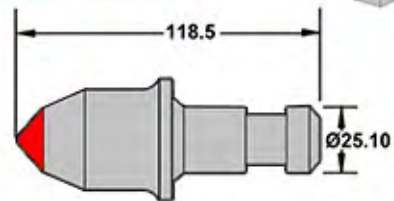

CP76HDD

Carbide Tooth for Hard Conditions

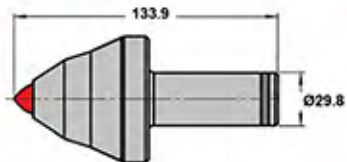

CP93HDD

Carbide Tooth for Hard Conditions

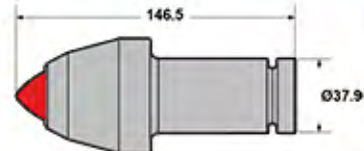

HDD WELD ON TEETH

HDD-12DCI-25-45

Weld on 12mm Insert Tooth, Height 25mm

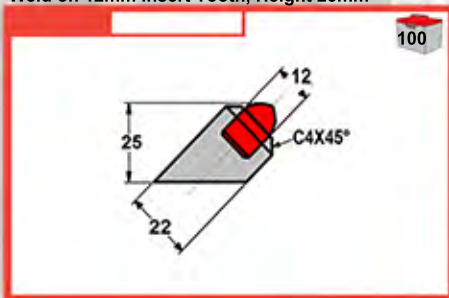

HDD-12DCI-32-45

Weld on 12mm Insert Tooth, Height 32mm

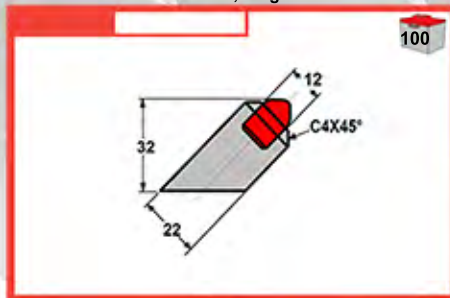

HDD-13CI-20-45

Weld On 13mm Cap, Tooth Height 20mm

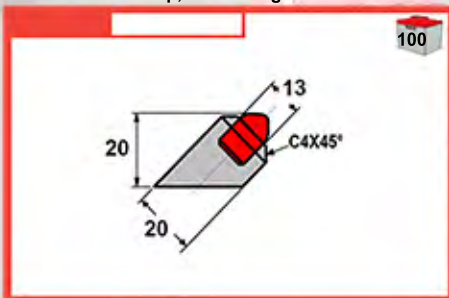

HDD-15CI-32-50-25

Weld on 15mm Cap, Tooth Height 32mm

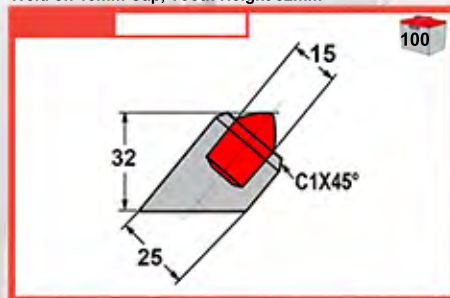

HDD WELD ON TEETH

HDD-16DCC-25-45

Weld on 16mm Cap, Tooth Height 25mm

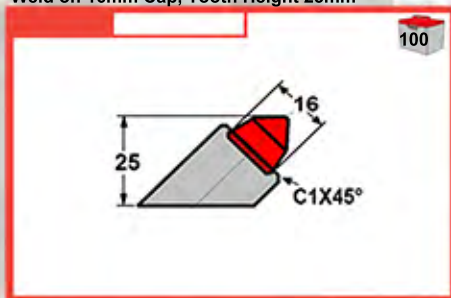

HDD-16DCC-32-45

Weld on 16mm Cap, Tooth Height 32mm

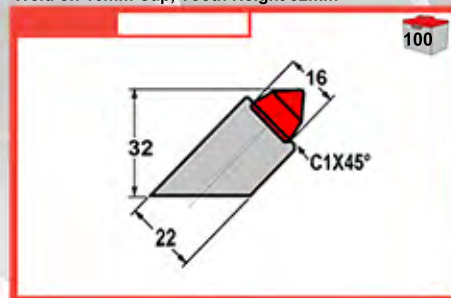

HDD-16DCC-33-90

Weld on 16mm Cap, Height 32mm, Angle=90

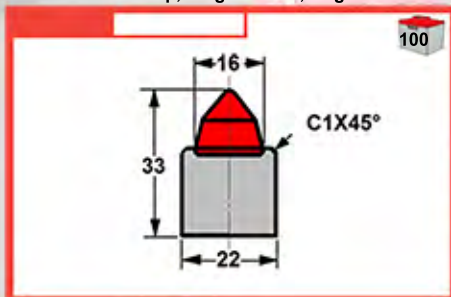

TRIHAWK PIN

Pin for trihawks

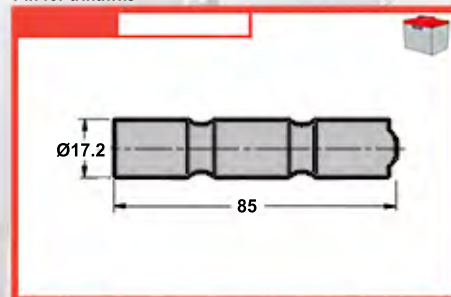

HDD WELD ON TEETH

EM405

Weld on Tooth, Height 44mm

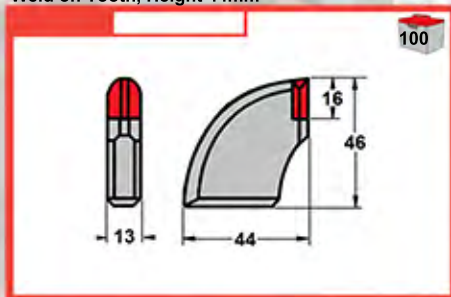

EM405-22

Weld on Tooth, Height 36.5mm

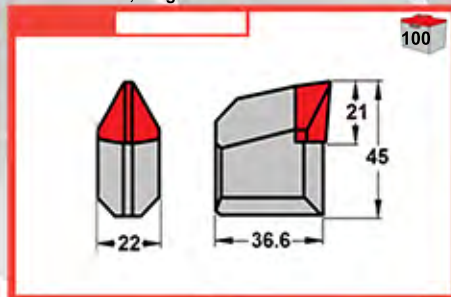

EM405-S

Weld on Tooth, Height 25.5mm

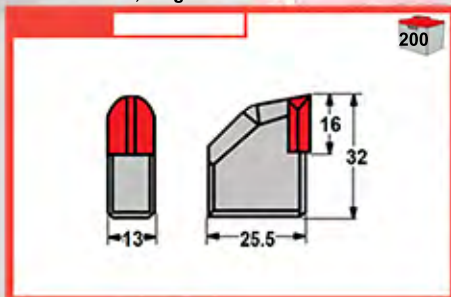

EM405-22L

Weld on Tooth, Height 57mm

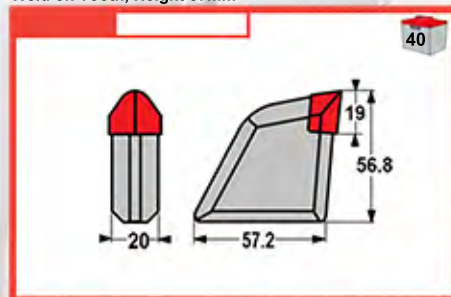

HDD WELD ON TEETH & ACCESSORIES

WELDONSEGMENT5

Replacement weld-on segment

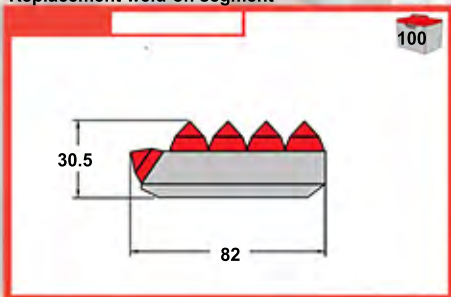

TBB-16DCC-BLOCK6

Replacement weld-on carbide segment, available from 2 to 6 teeth

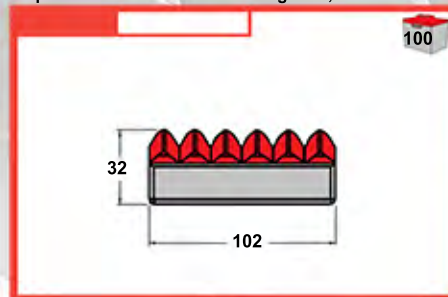

TRIHAWK SHOE

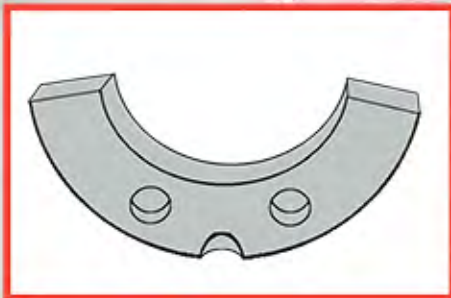

DRILL PIPE

**DRILL PIPE AVAILABLE
CONTACT US FOR INFORMATION**



TRENCHER TEETH

ERTR1, ERTR2, ERTR3

Bolt-on trencher teeth. These 3 products differ only by the tilt-angles

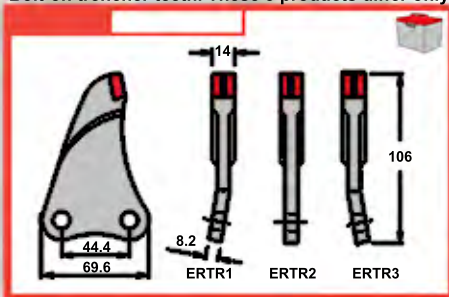

ERTR4

Bolt-on trencher teeth

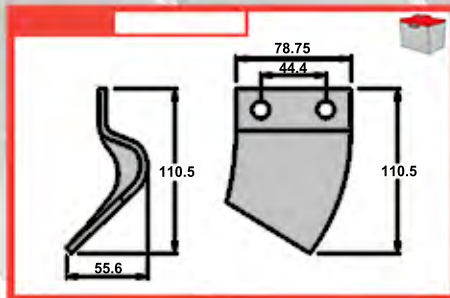

ERTR5

Bolt-on trencher teeth

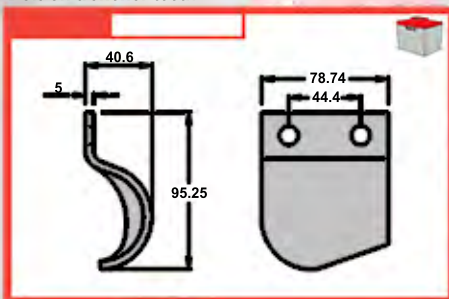

ERTR6

Bolt-on trencher teeth

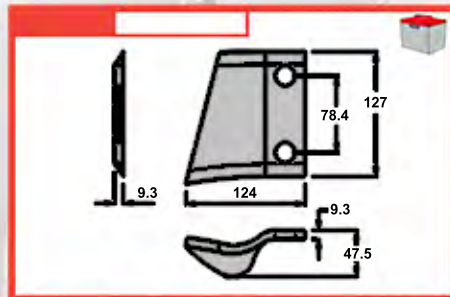

DRILL BITS

EMTCI

Tricone, Carbide Button Bit



EMMT

Tricone, Steel Tooth Bit



EMPDC

Tricone, PDC Bit



Contact us directly
for information
about variety of
bit sizes & types

MODHAWK HDD BIT

Hard Surfacing and Carbide Buttons Available

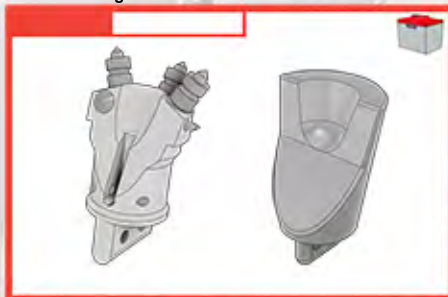

HDD ACCESSORIES

SAVER SUBS & CROSSOVERS

Available as requested



AUGER FLIGHT MANUFACTURING

Available as requested



TRIHAWKS

Available as requested



SHAKER SCREENS

Available as requested



TRIHAWK & THREAD REPAIR

TRIHAWK REPAIR - BEFORE



TRIHAWK REPAIR - AFTER



*EXCHANGE PROGRAM
AVAILABLE!!*

THREAD REPAIR - BEFORE

Repairs of any thread types available



THREAD REPAIR - AFTER

Repairs of any thread types available



HOLE OPENERS

HDD HOLE OPENERS

Wombat PDC, Fluted, Stack Plate and Batter Reamers Available

REAMER RENTAL

All Sizes Available, Call For Quote



**RENTALS
AVAILABLE!**

ROCKET

Your #1 Choice For Hard Formation!



WOMBAT

Standard Body Types

Product Code	Item Description
RB1.S4	Wombat Reamer Body 2 3/8" IF D=10"-16"
RB2.S4	Wombat Reamer Body 2 3/8" IF D=16"-22"
RC1.S4	Wombat Reamer Body 2 7/8" IF D=10"-16"
RC2.S4	Wombat Reamer Body 2 7/8" IF D=16"-22"
RD1.S4	Wombat Reamer Body 3 1/2" IF D=12"-24"
RD2.S4	Wombat Reamer Body 3 1/2" IF D=18"-30"
RE1.S4	Wombat Reamer Body 4 1/2" IF D=12"-30"
RE2.S4	Wombat Reamer Body 4 1/2" IF D=16"-36"
RF1.S4	Wombat Reamer Body 6 5/8" FH D=16"-28"
RF2.S4	Wombat Reamer Body 6 5/8" FH D=24"-42"
RF3.S4	Wombat Reamer Body 6 5/8" FH D=36"-60"

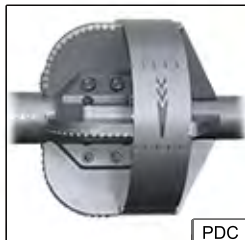

PDC

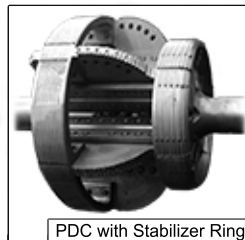

PDC with Stabilizer Ring

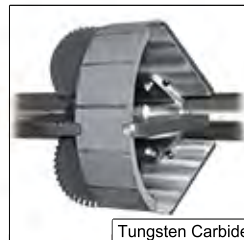

Tungsten Carbide

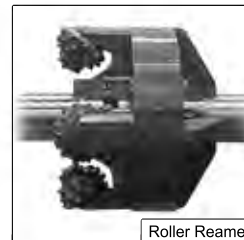

Roller Reamer

MULCHING TEETH

C Style Single Face

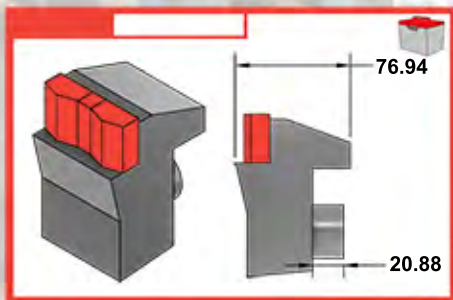

C Style Double Face

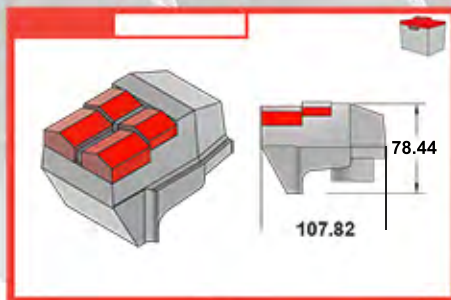

IRONWOLF 25MM



IRONWOLF 38/30MM

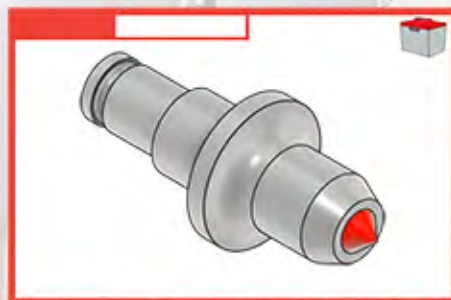

Forestry

SG19CS-LR

Bent/Straight - Round-Tooth Holder

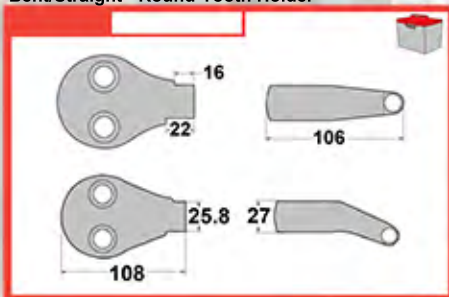

SG19TH-LR

Bent/Straight - Countersunk Round-Tooth Holder

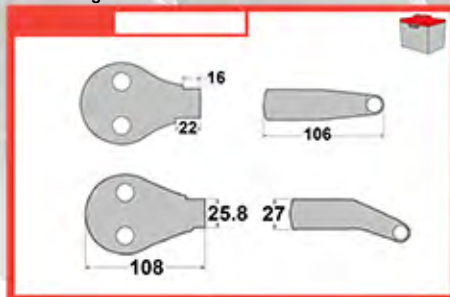

SG001-SR

Straight Right Grinder Tooth

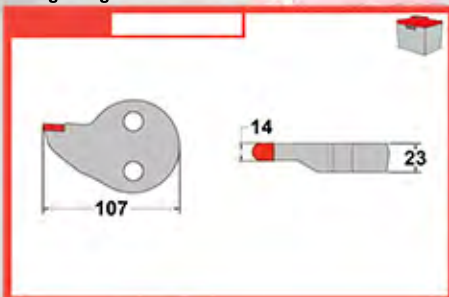

SG19X0.375UN

Round Tooth

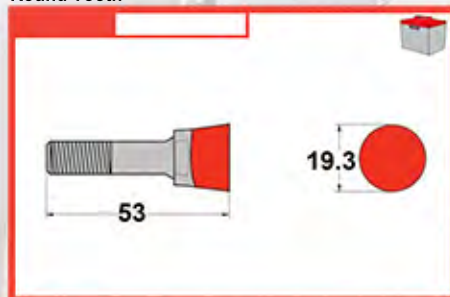



*THANK YOU!!
THANK YOU!!
THANK YOU!!*



THANK YOU FOR YOUR BUSINESS!



CONTACT INFORMATION

HARDMETALS CANADA INC.

CALGARY

Address:

Unit 6, 9550 114th Avenue SE
Calgary, T3S 0A5, Canada

Office phone:

+1 403 523 9232

Ervin Bata

+1 403 615 6163

ervin@hardmetals.com

Arpad Meszaros Gergely

+1 587 439 1205

canada@hardmetals.com

EDMONTON

Address:

Unit 100, 26657 - 111 Ave
Acheson, Edmonton, Canada

Contact

brandi@hardmetals.com

+1 780-445-0369

HARD METALS AUSTRALIA PTY LTD

Address:

40 Peter Brock Drive
Eastern Creek, NSW 2766

Phone: +61 2 9009 4455

Fax: +61 2 9009 4456

Web:

www.hardmetals.ca

www.hardmetals.com

